

12 & 24 Volt
DC VIBRATORS

**Mobile Applications
Low Maintenance**



**SILENT
TRUCK
SPREADER
PUMP**

We're The Vibrator Guys.™

VIBCO

www.vibco.com

12 VOLT DC VIBRATORS

DC-60

The DC-60 is our smaller vibrator for screens on concrete pumps. It is watertight and ideal for spreaders, sanders and fertilizer hoppers. With 3600 RPM and 60 lbs. of force it comes either in lightweight aluminum or cast iron housings.



CONCRETE PUMP VIBRATORS

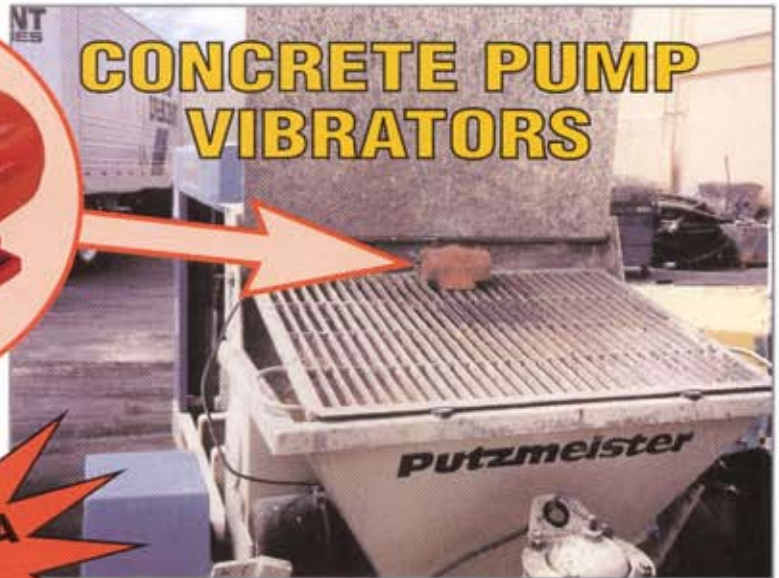

ASK ABOUT A FREE TRIAL

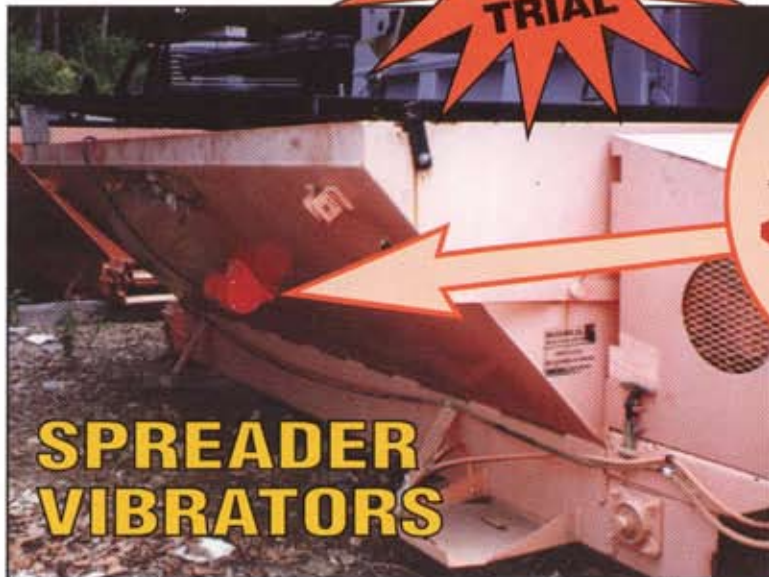

DC-100

Perfect size and force for small aggregate hoppers up to 1-1/2 yds. and tailgate spreaders. 100 lbs. of force at 4000 RPM and 12 amperes. For larger hoppers & spreaders use Model DC-450 or DC-700.

DC-300 & DC-500

DC-300 produces up to 400 lbs. of force and DC-500 up to 450 lbs., both at 4000 RPM. Rated for continuous duty. Both units are ideal for concrete pumps to keep concrete flowing through the screen uninterrupted and to screen off large aggregates that won't go through the pump. DC-500 is totally enclosed and watertight to withstand pressure hose cleanup. DC-300 is totally enclosed. Both units can also be used on concrete chutes, hoppers and spreaders, etc.



12 VOLT DC VIBRATORS



**HEAVY
SPREADER
VIBRATORS**

DC-450 & DC-700

DC-450 produces up to 500 lbs. of force and DC-700 produces up to 700 lbs. of force both at 4000 RPM. Two hole mount with heavy duty construction. Both are perfect for ag. lime and fertilizer spreaders (see below), concrete batch hoppers, tailgate spreaders, mobile bins and hoppers. Picture at left shows DC-450 on sand spreader.

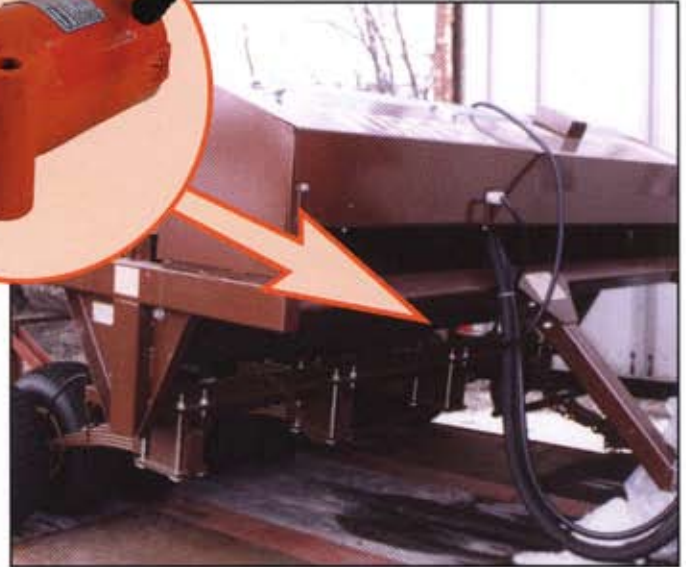

**MOBILE
APPLICATIONS**

DC-900

900 lbs. force at 6000 RPM. Four hole mount for the

heavy duty applications. Ideal for medium size bins and hoppers and large V-style spreaders. Picture shows DC-900 on a fertilizer truck



DC-1600

1600 lbs. of force at 5000 RPM. Ideal for hopper spreaders, large mobile bins, concrete spreaders and small dump bodies. Picture shows DC-1600 on street sweeper used to shake mud and sand out of hopper.



**STREET SWEEPER
VIBRATORS**

BIG BERTHA

DUMP BODY VIBRATORS

FOR FAST, SAFE & COMPLETE DISCHARGE OF
STICKY OR WET MATERIALS

PLUS VALUES:

1. Eliminate destructive slamming of brakes, jerking of hoists, and banging tailgates and reduce expensive damage on brakes, transmissions, clutches, tailgates and rear ends.
2. Increase the number of loads hauled and dumped per day.
3. Insure a complete, clean dump every time.
4. Spread while dumping, reducing manpower and machine time.
6. Minimize the tip-over problem by allowing discharge at lower dumping angles.

**ASK
ABOUT A
FREE
TRIAL**



DC-3500

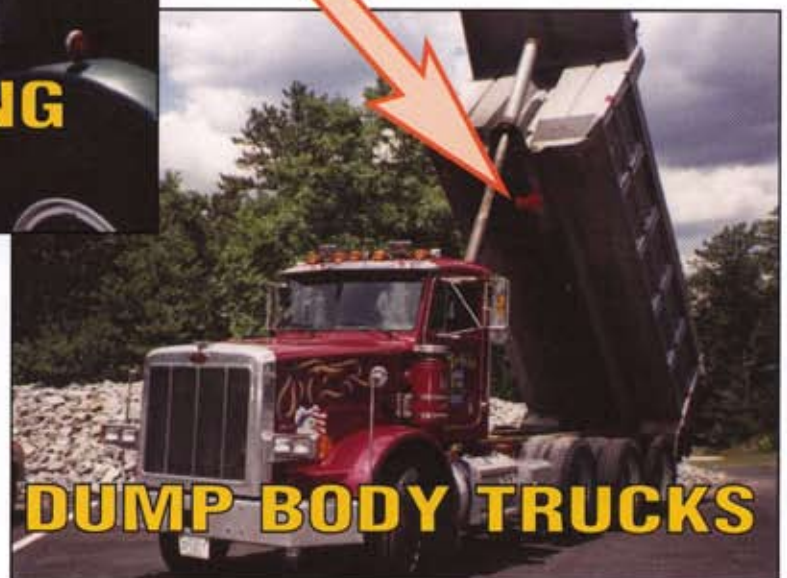

"The Best in the Industry"

- DC-3500 for trucks over 10 cu. yd., 22,400-48,000 lbs. load; multi-axle dump trucks and trailers.
- DC-3500-1000 for dump body trucks up to 3 cu. yd. or 7000-15,000 lbs. load; bulk-feed truck hoppers.
- DC-3500-2900 for up to 10 cu. yd. or 18,900-40,500 lbs. load; tandem axle dump trucks.

TECHNICAL DATA

Model	lbs. Force	N	Amps.**	Volts	Ph.	Max. Speed	dB*	lbs. Weight	kg.	Duty Cycle
DC-20	20	89	3.7	6 & 12 DC	1	3500	68	3	1.4	Cont.
DC-50	50	223	3	12 & 24 DC	1	3600	71	6	2.72	Cont.
DC-60	60	267	3	12 & 24 DC	1	3600	68	8**	3.6	Cont.
DC-100	100	445	12	12 & 24 DC	1	4000	72	4	1.8	Cont.
DC-200	300	1334	14	12 & 24 DC	1	4000	73	8	3.6	Cont.
DC-300	350	1557	16	12 & 24 DC	1	4000	74	9	4.0	Cont.
DC-450	400	1780	22	12 & 24 DC	1	7000	75	17	7.7	Cont.
DC-500	450	2005	16	12 & 24 DC	1	4000	73	12	5.5	Cont.
DC-700	700	3115	25	12 & 24 DC	1	6000	75	20	9.1	Int.
DC-900	600	2669	30	12 & 24 DC	1	6000	78	20	9.1	Special
DC-1600	1000	4450	32	12 & 24 DC	1	5000	82	30	13.6	Special
DC-3500	3500	15572	60	12 & 24 DC	1	4000	70	36	16.3	Special

NOTE: The frequency will vary with the load. *Decibel on A-scale at 3' (1 meter)
 **Amps shown for 12 volt DC (24 volt amps 1/2 of 12 volts)

N = Centrifugal force in Newton.

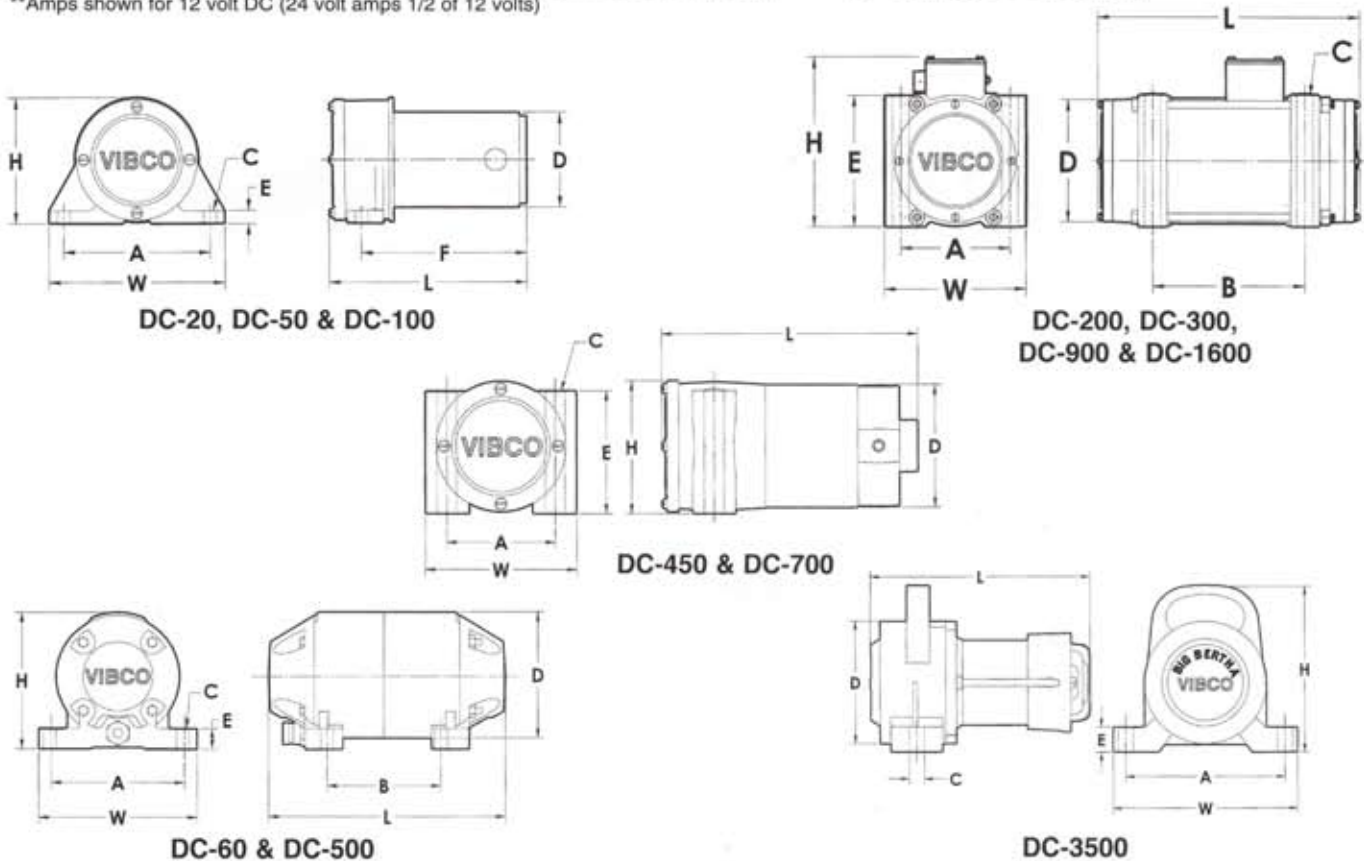

DIMENSIONS

Model	L		W		H		A		B		C*		D		E	
	inch/mm	inch/mm	inch/mm	inch/mm	inch/mm	inch/mm	inch/mm	inch/mm	inch/mm	inch/mm	inch/mm	inch/mm	inch/mm	inch/mm	inch/mm	inch/mm
DC-20	5	127	5	127	3 1/4	89	4	102	—	3/8	10	3	76	3/8	—	10
DC-50	5 1/4	143	5	127	3 1/4	84	4	102	—	3/8	10	2 1/2	64	3/8	—	10
DC-60	6 1/4	162	4 1/2	114	3 1/4	83	3 3/4	94	1 1/8	33	3/16	8	3	76	3/8	10
DC-100	6 1/4	171	6	152	4 1/4	108	5	127	—	3/8	10	3 3/8	86	—	—	—
DC-200	8 1/2	216	4 1/4	105	5	127	3	76	5 1/4	145	3/16	8	3 3/8	90	—	—
DC-300	9	229	4 1/4	105	5	127	3	76	5 1/4	145	3/16	8	3 3/8	90	—	—
DC-450	8 1/4	210	4 3/4	124	4 1/4	105	3 1/2	89	—	1/2	12	4	102	6 1/2	165	—
DC-700	7 3/4	197	5 3/4	143	5 1/4	133	4 1/2	114	—	1/2	12	5 1/8	128	6 1/2	165	—
DC-500	9	229	6 1/4	159	5 1/2	140	5 1/4	133	4 1/2	114	7/16	11	—	—	—	—
DC-900	11 1/4	283	5 1/2	140	6 1/4	160	3 1/2	89	6 3/8	168	1/2	12	4	102	—	—
DC-1600	11 1/4	286	5 3/4	143	6 1/4	159	4 1/2	114	7	178	1/2	12	4 1/2	184	—	—
DC-3500	12	305	10	254	9	229	8 1/2	216	—	3/4	19	3	76	—	—	—

*Bolt Size NOTE: Dimensions and Technical Data subject to change without notice.

WE ALSO SUGGEST:

HYDRAULIC VIBRATORS



VIBCO hydraulic models are low cost alternatives that provide high force at low frequencies. Built for continuous duty with specially designed motors that last longer than standard hydraulics, these workhorses operate in any position. Best for the toughest unloading jobs and moving materials in huge bins and hoppers.

PNEUMATIC PISTON VIBRATORS



WHEN CONSIDERING PNEUMATIC UNITS, BE SURE YOU HAVE THE PROPER AMOUNT OF **LUBRICATED AIR FLOW** (CFM - CUBIC FEET PER MINUTE) AND AIR PRESSURE (PSI - POUNDS PER SQUARE INCH) TO PROPERLY POWER THE UNIT.

Choose pneumatic piston style vibrators for applications that need high impact linear force. Built to move even the most stubborn, sticky material you have, these units can take the abuse and will last a long time with the proper lubricated air supply. Flange mounted with industry standard bolt patterns for easy exchangeability.

*** ASK ABOUT A FREE TRIAL ****

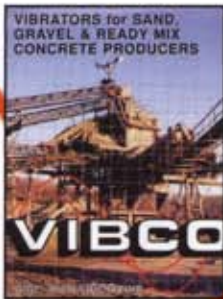

CAT. #9803
Vibrators for Sand & Gravel

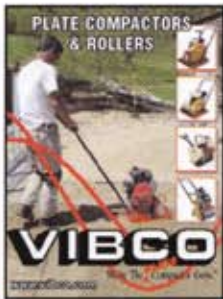

CAT. #9808
Plate Compactors & Rollers

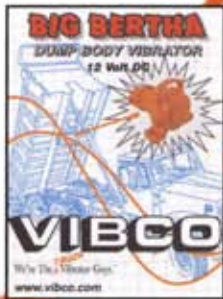

CAT. #9511C
Big Bertha Dump Body Vibrators



CAT. #9001C
General Catalog

ADDITIONAL PRODUCT BROCHURES
ASK FOR YOUR FREE COPIES TODAY



Corporate HQ & Factory:
75 Stilson Road, P.O. Box 8
Wyoming, RI 02898
E-Mail: vibrators@vibco.com
Phone: (401) 539-2392
(800) 633-0032
FAX: (401) 539-2584

Western US:
Phoenix, AZ 85254
Phone: (480) 596-1809
(800) 633-0032
FAX: (480) 596-1614

Southeastern US:
Charlotte, NC 28277
Phone: (401) 539-2392
(800) 633-0032
FAX: (401) 539-2584

Canada:
2215 Dunwin Drive
Mississauga, ONT L5L 1X1
Phone: (905) 828-4191
(800) 465-9709
FAX: (905) 828-5015

We're The ^{SILENT} Vibrator Guys.™

PRINTED IN USA
9112C ©2005 VIBCO, INC.

800-633-0032 • www.vibco.com